

## Index

SIDE CONNECTOR SET 1 M/ 5 M	2
SIDE EXTENSION CORD	3
POWER EN CONNECTION DIAGRAM	4
SYMBOLS	5



## liniLED® Side Connector Set 1 m/ 5 m



### Product information

Dimensions	L31xW15xH17 mm
Cord length	1 m, 5 m
Degree of protection	IP40 (IP68 with Cast joint or Side Mirror Welded connector)
Colour	White
Power cord	White, PVC
Weight	1 m: 53 g 5 m: 179 g
Included	liniLED® Side End Cap (15504)

Product code	Description
11202	liniLED® Side Connector Set 1 m
11193	liniLED® Side Connector Set TW 1 m
11206	liniLED® Side Connector Set RGB 1 m
11203	liniLED® Side Connector Set 5 m <sup>1</sup>
11194	liniLED® Side Connector Set TW 5 m <sup>1</sup>
11207	liniLED® Side Connector Set RGB 5 m <sup>1</sup>

<sup>1</sup> Check in in Cable Selection table (in the Datasheet of the chosen led strip) what the maximum length of the cable is with the chosen led strip length.

### Product drawing

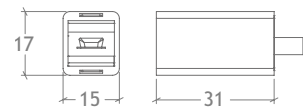

## liniLED® Side Extension Cord

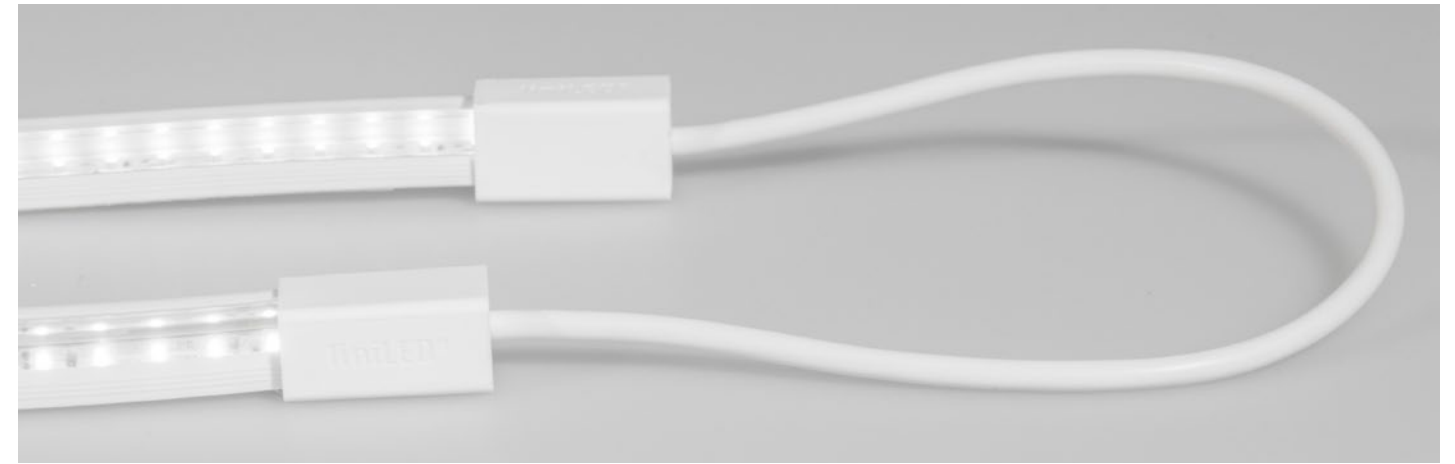

### Product information

Dimensions	L31xW15xH17 mm
Cord length	26 cm
Degree of protection	IP40 (IP68 with Cast joint or Side Mirror Welded connector)
Colour	White
Power cord	White, PVC
Weight	32 g (RGB 33 g)

Product code	Description
11209	liniLED® Side Extension Cord
11195	liniLED® Side Extension Cord TW
11211	liniLED® Side Extension Cord RGB



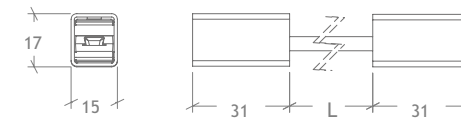



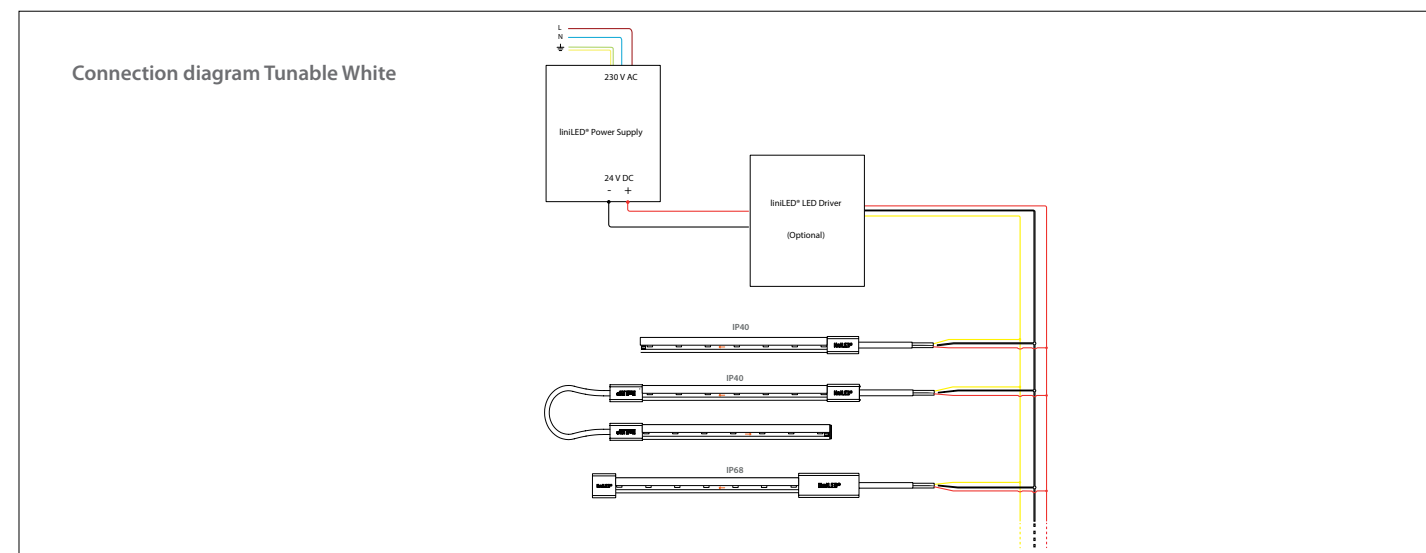
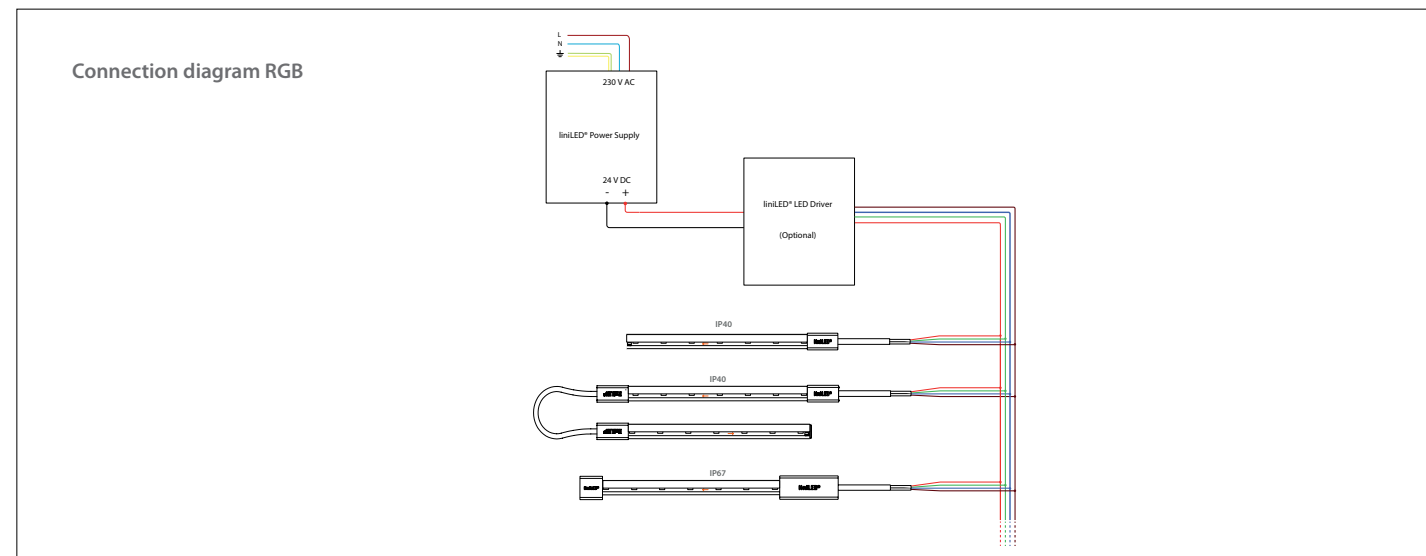
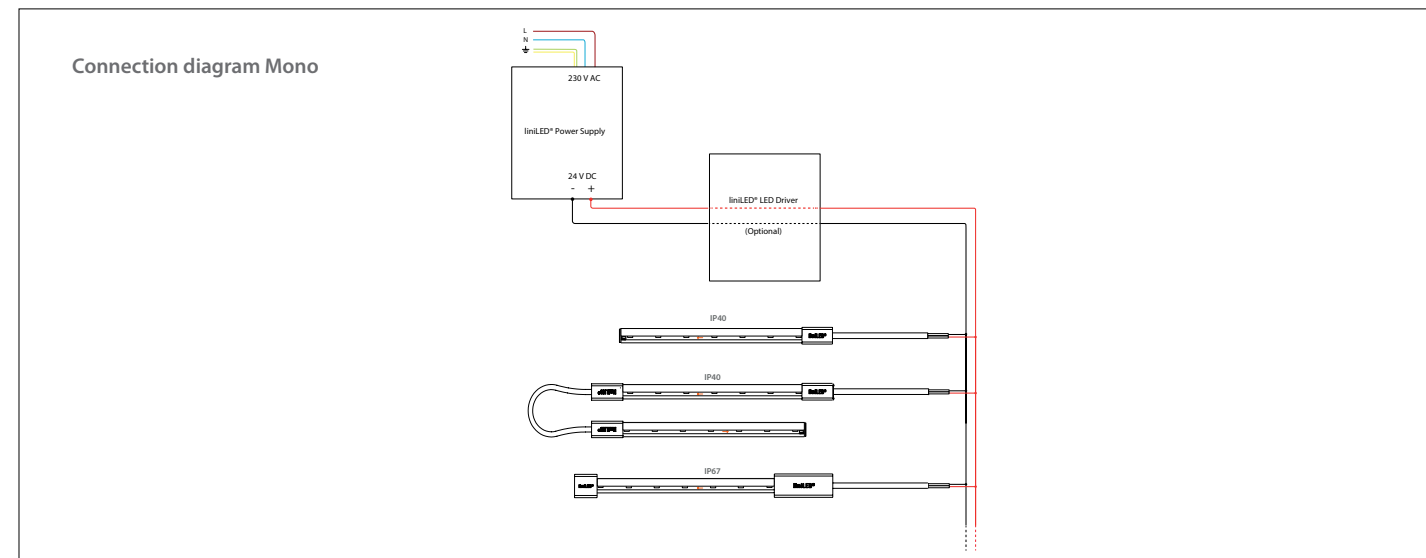

### Product drawing



## Power and connection diagram



## Symbols

-  Manufacturer's declaration that the product meets the applicable EC directives.
-  Restriction of Hazardous Substances (RoHS): product complies with the RoHS directive and each homogeneous material does not exceed the limits for the materials mentioned under the RoHS directive (Pb, Hg, Cd, Cr6+, PBB and PBDE).
-  Protected against ingress of solid foreign objects  $\geq 1.0$  millimetres. Not-protected against ingress of water.
-  Dust-tight, no ingress of dust. Protected against the effects of temporary immersion in water (Immersion in water at a maximum depth of 1 metre up to half an hour).
-  Electrical appliance class III: this product is designed to be supplied from an extra-low voltage ( $\leq 60.0$  V DC or  $\leq 42.4$  V AC).
-  Product is resistant against ultraviolet (UV) light or sunlight. Non-UV resistant products can degrade or discolor fast when exposed to UV light.
-  Product can be cleaned with normal cleaning agents as specified in the datasheet under 'chemical compliances'.
-  This product can be stored and used below 0 degrees Celsius. Verify the minimum storage and operation temperature in the datasheet for the lowest temperature allowed.
-  System guarantee of 5 years when the complete system consist of liniLED® Products with the 5 year system warranty logo.